

AD/BOARD		MODEL	OF0576			泓瑜科技有限公司 WINSONIC TECH. CO., LTD.						
INVERTER											VERSION	MATERIAL
KEY PAD						V3	METAL	2012-Apr-23	APPROVED		DRAWN	JACK

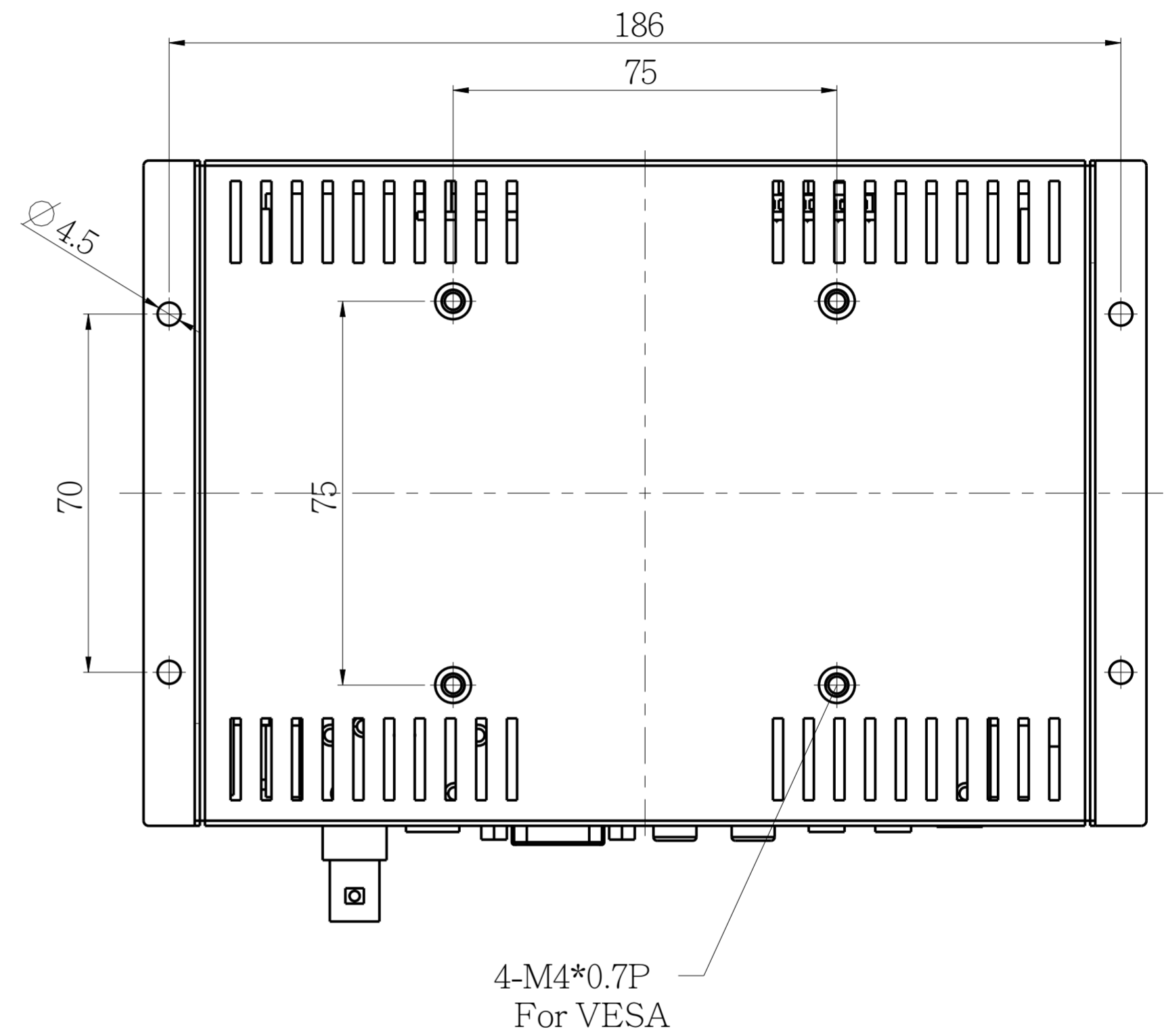
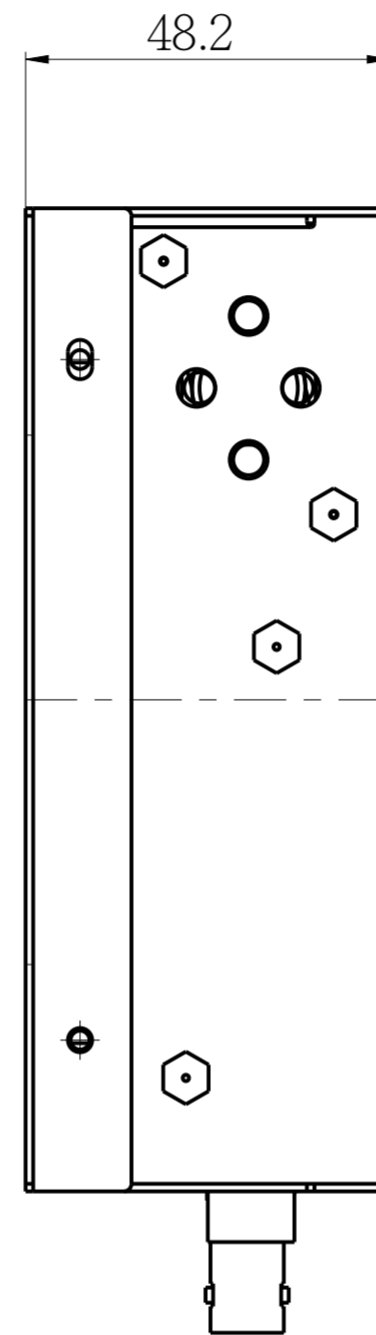
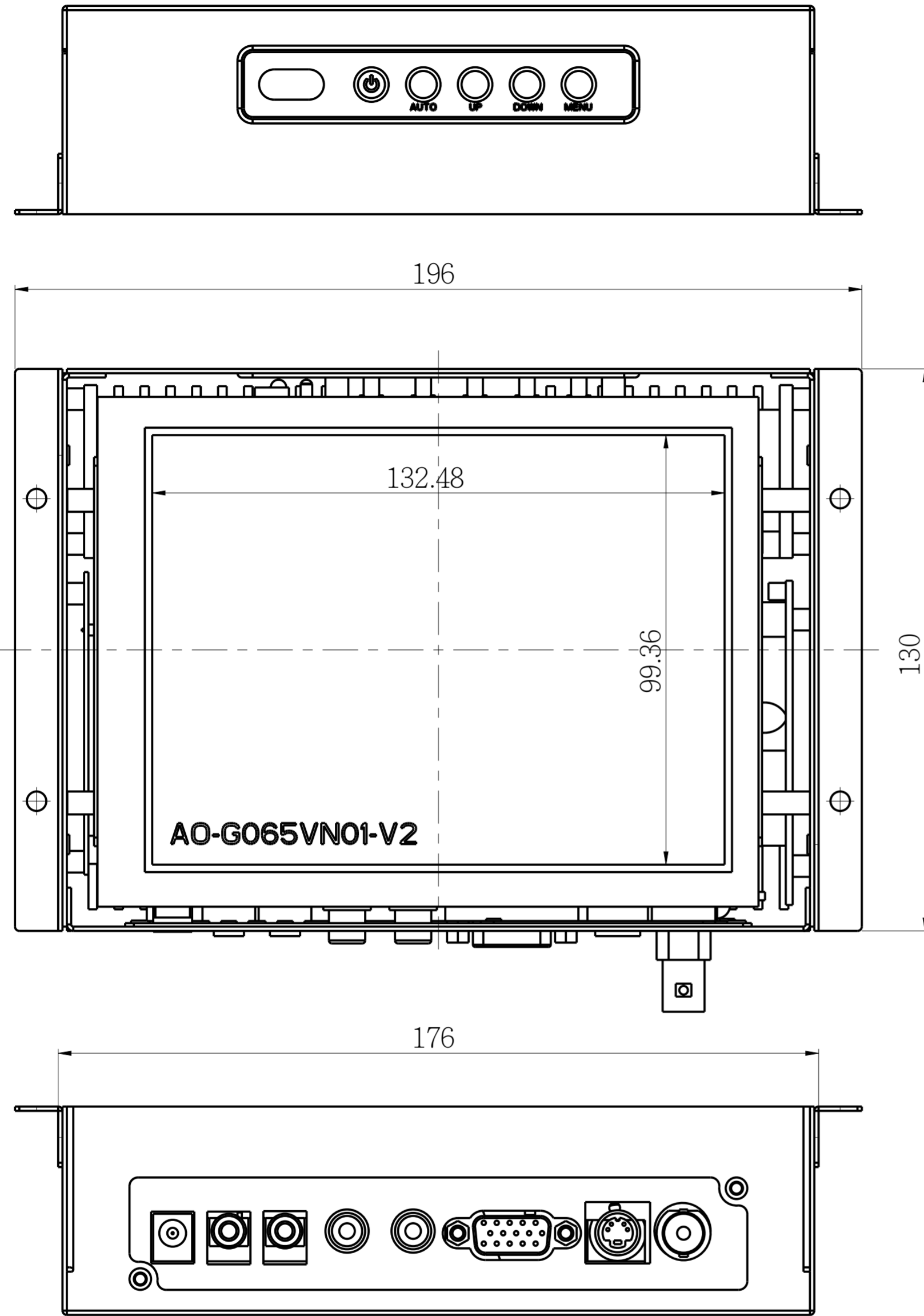

AD/BOARD		MODEL	OF0656			泓瑜科技有限公司 WINSONIC TECH. CO., LTD.				
INVERTER		PART NO.				PART NAME	ASSEMBLY		⊕	⚠
KEY PAD		VERSION	MATERIAL	DATE		APPROVED	DRAWN	Jack	SCALE	1.000
PANEL:	V1		METAL	2012-Mar-13					NUIT	MM

1

2

3

4

5

D

C

B

A

A

B

C

D

A

B

C

D

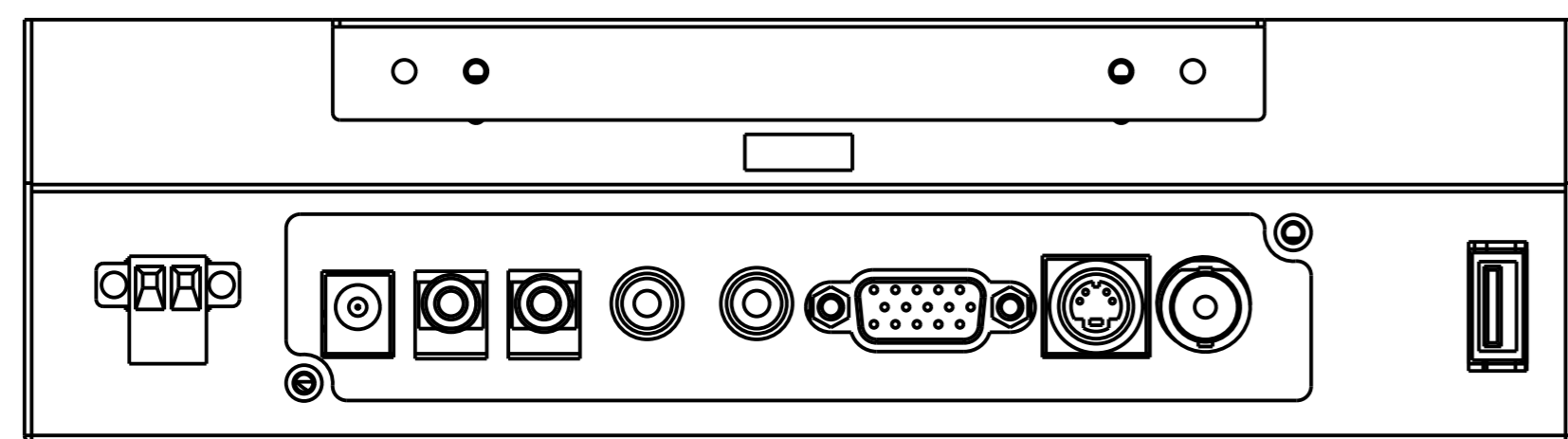
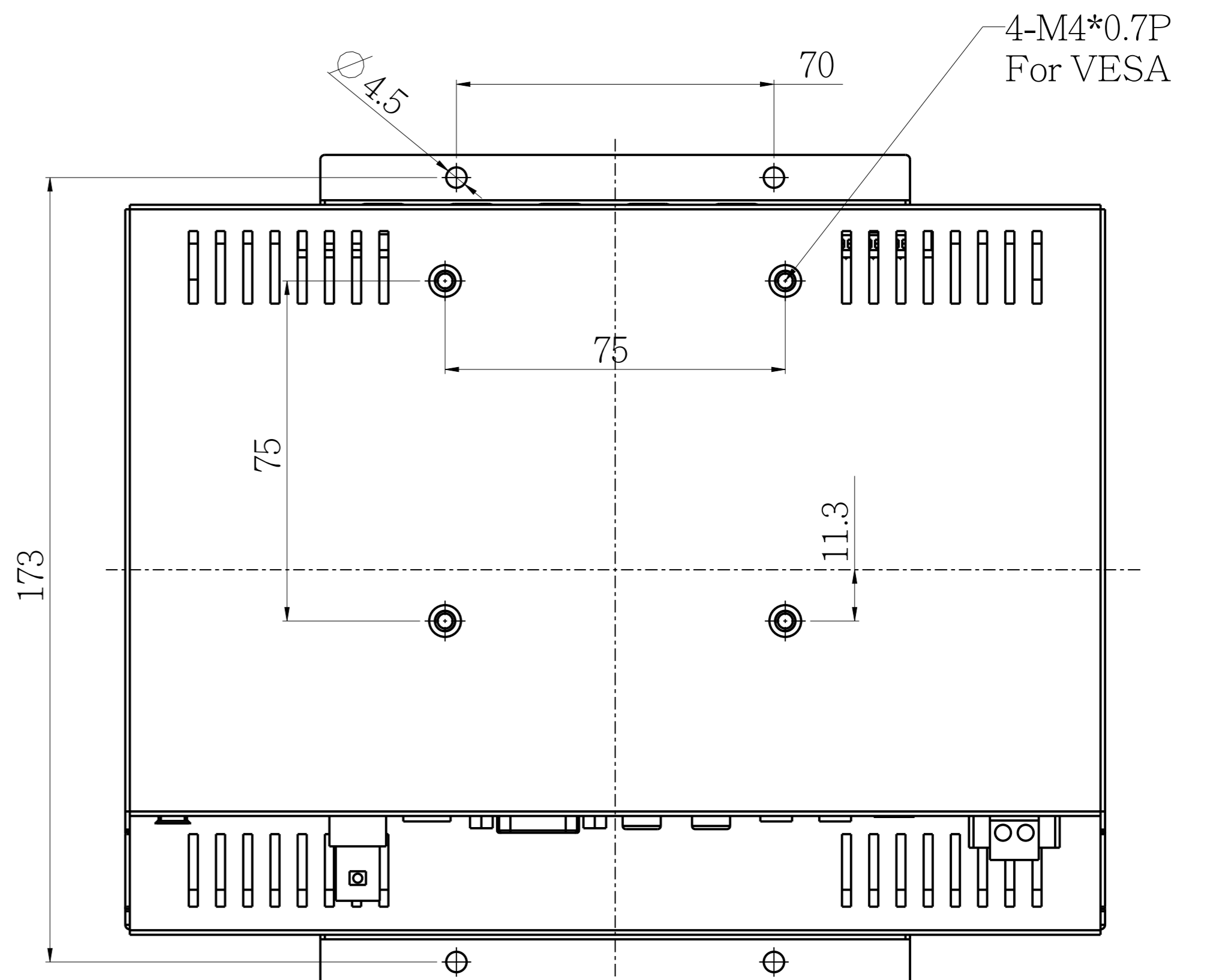
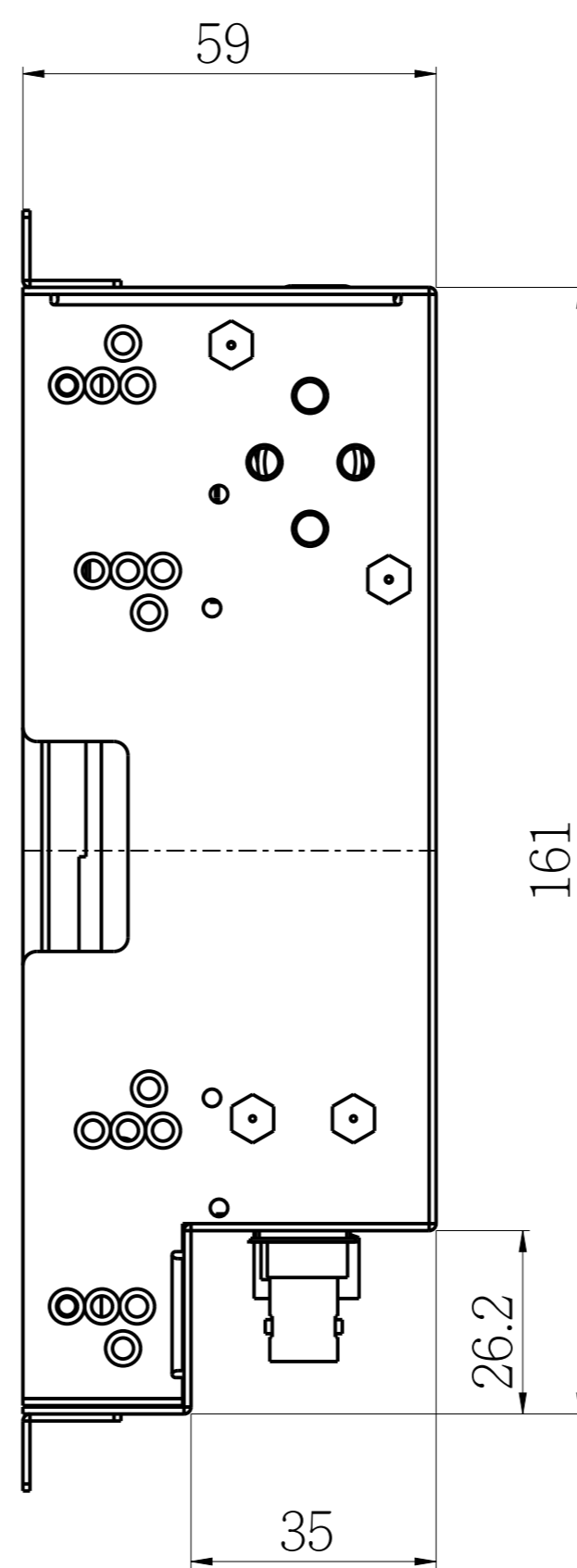
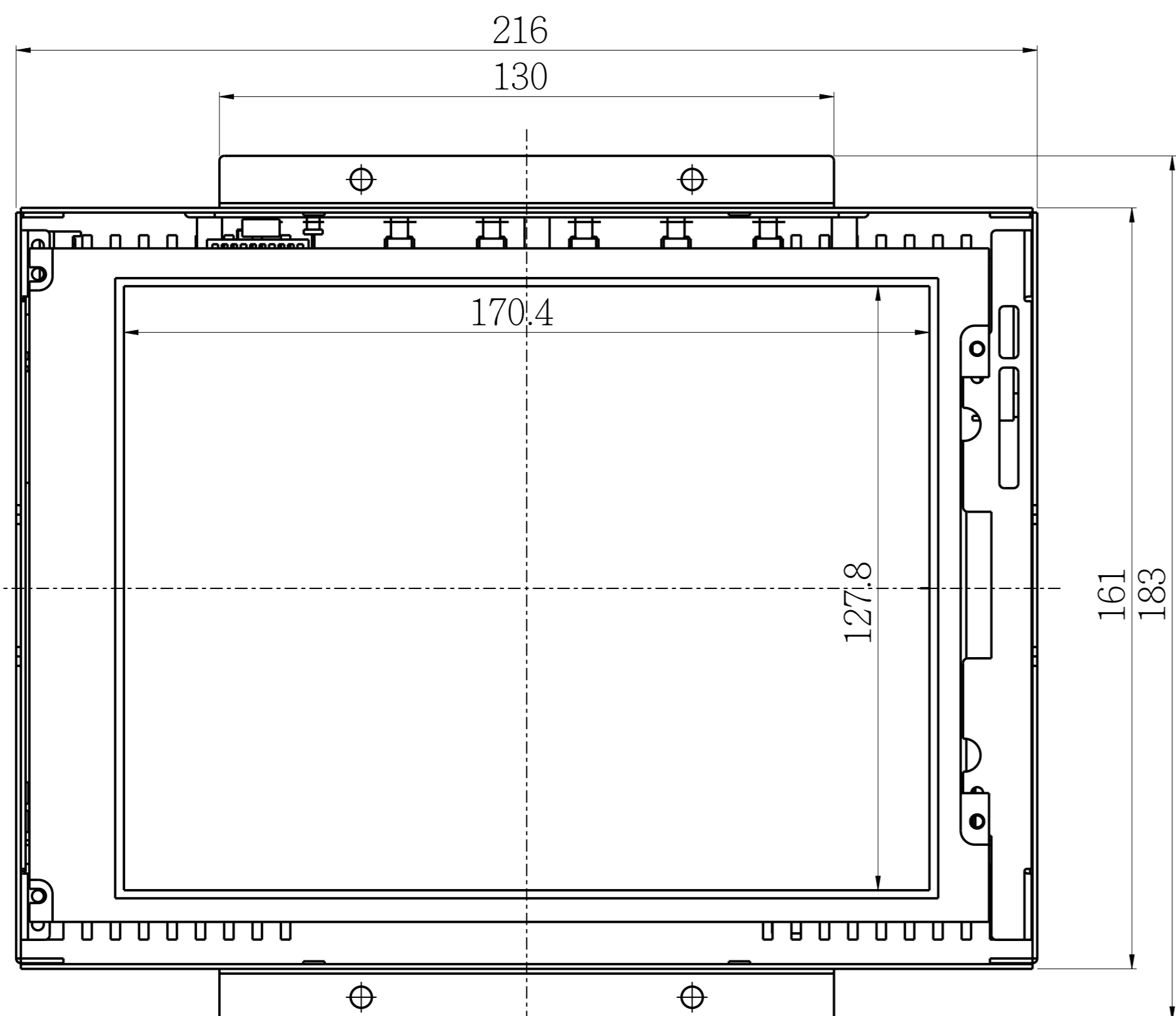
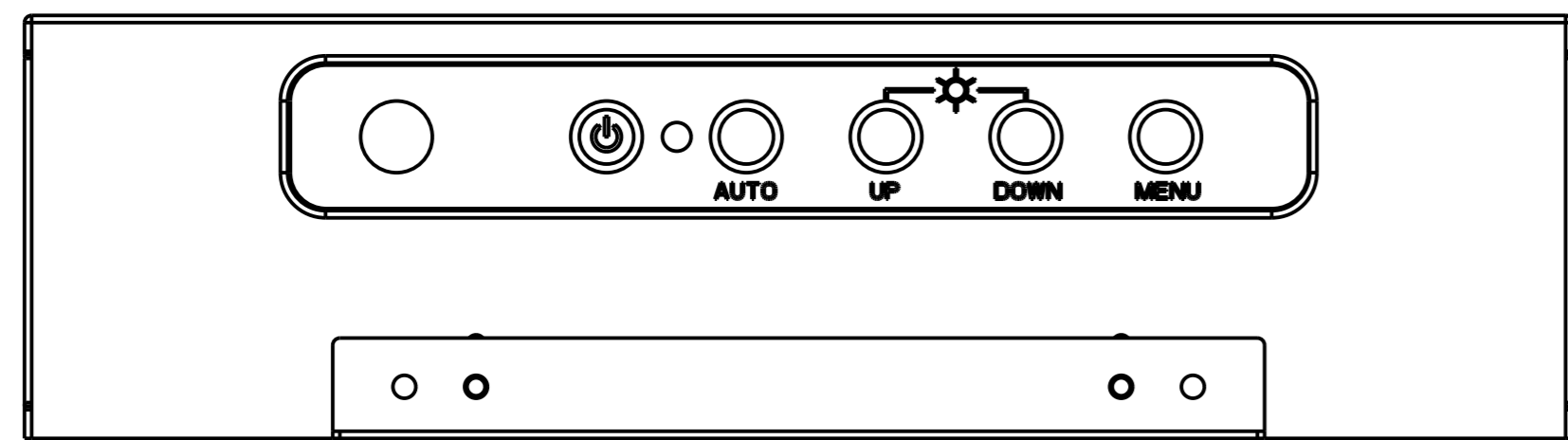

AD/BOARD		MODEL	OF0846	泓瑜科技有限公司 WINSONIC TECH. CO., LTD.			
INVERTER		PART NO.					
KEY PAD		MATERIAL	METAL	DATE	2012-Feb-06	APPROVED	
PANEL:						DRAWN	Jack
						SCALE	1.000
						UNIT	MM

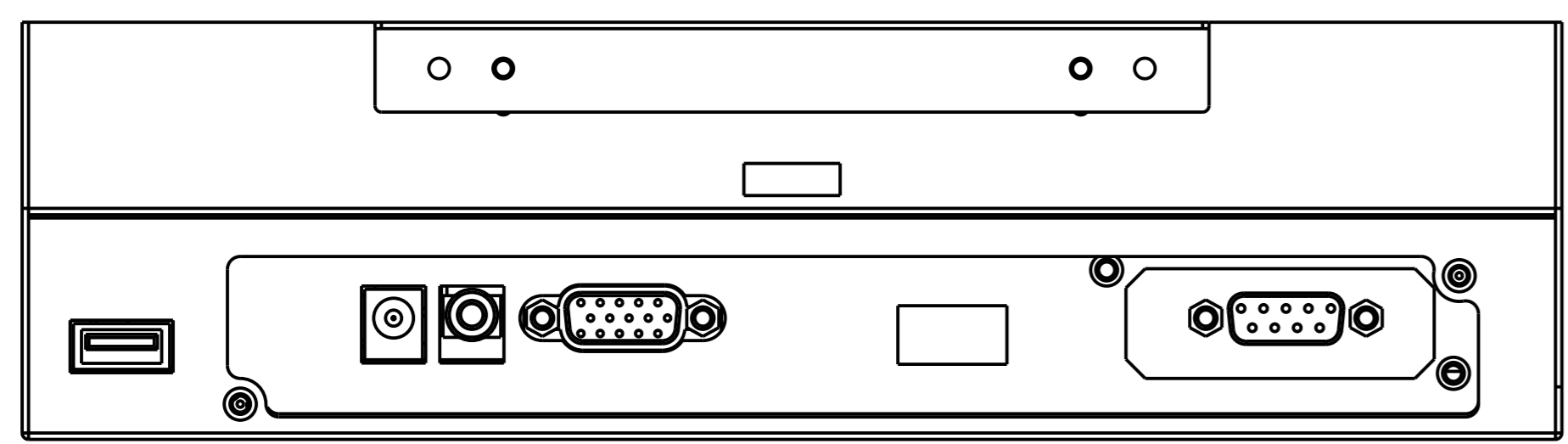
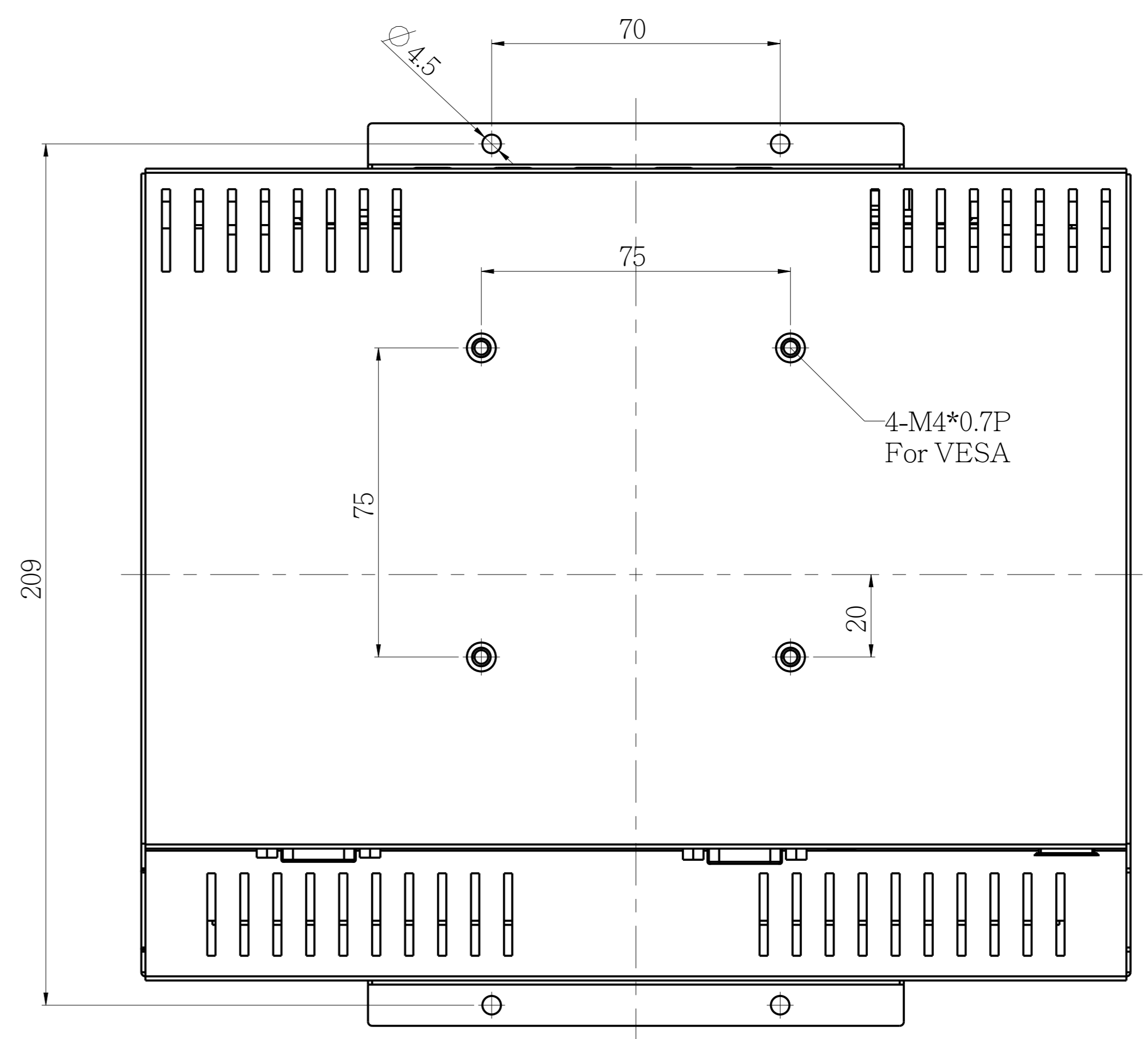
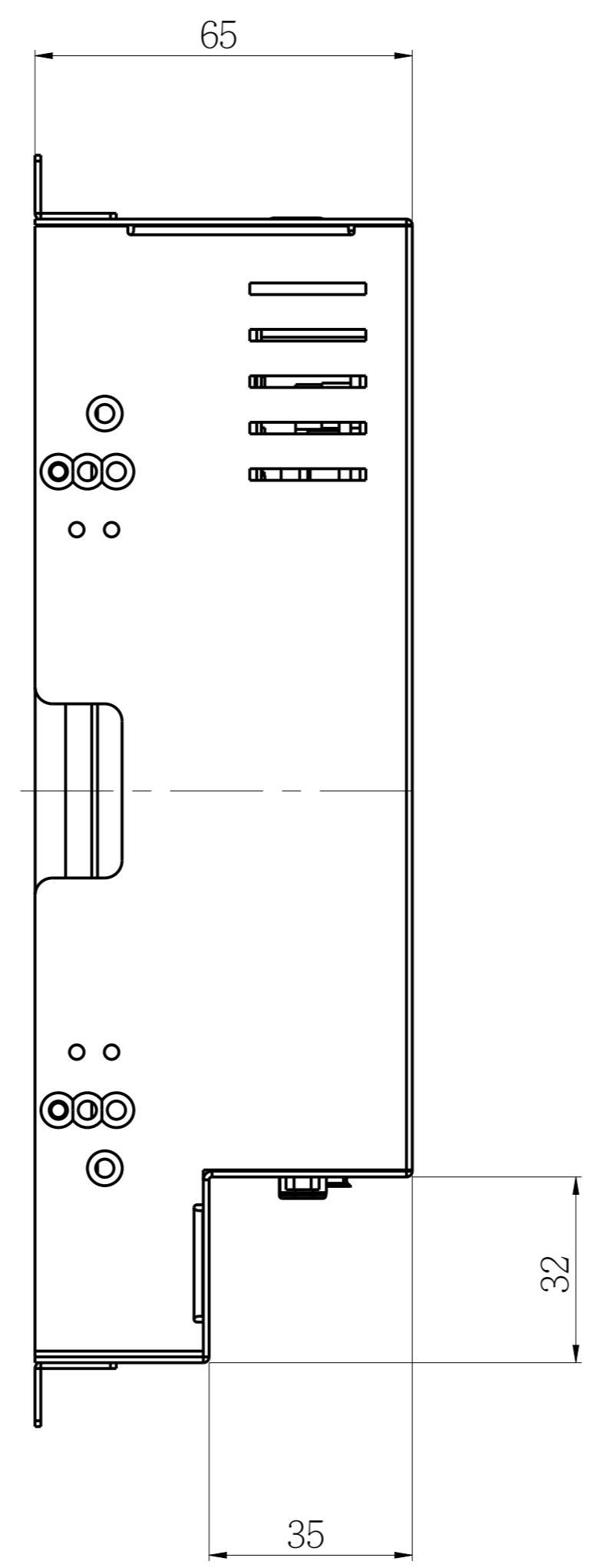
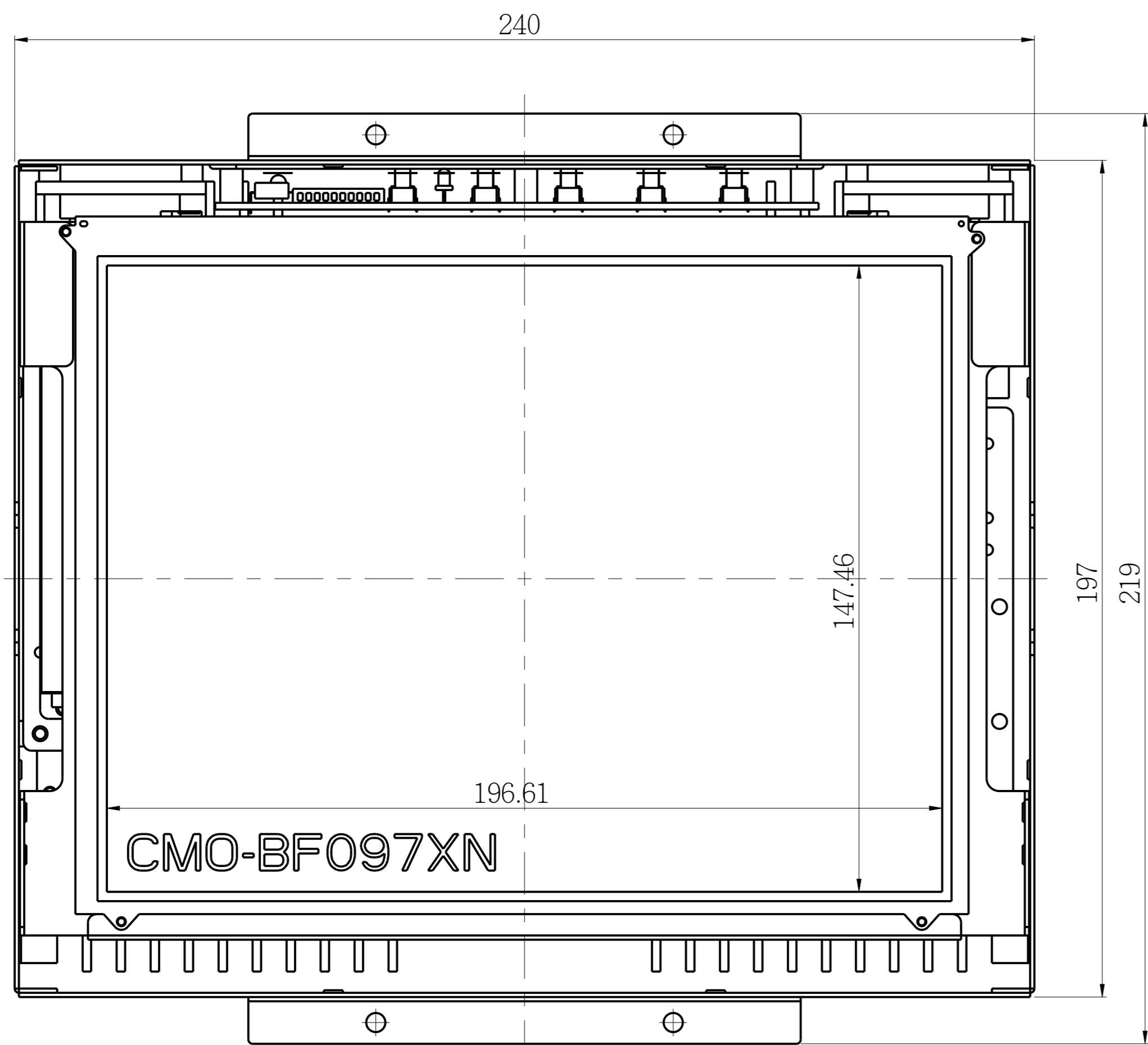
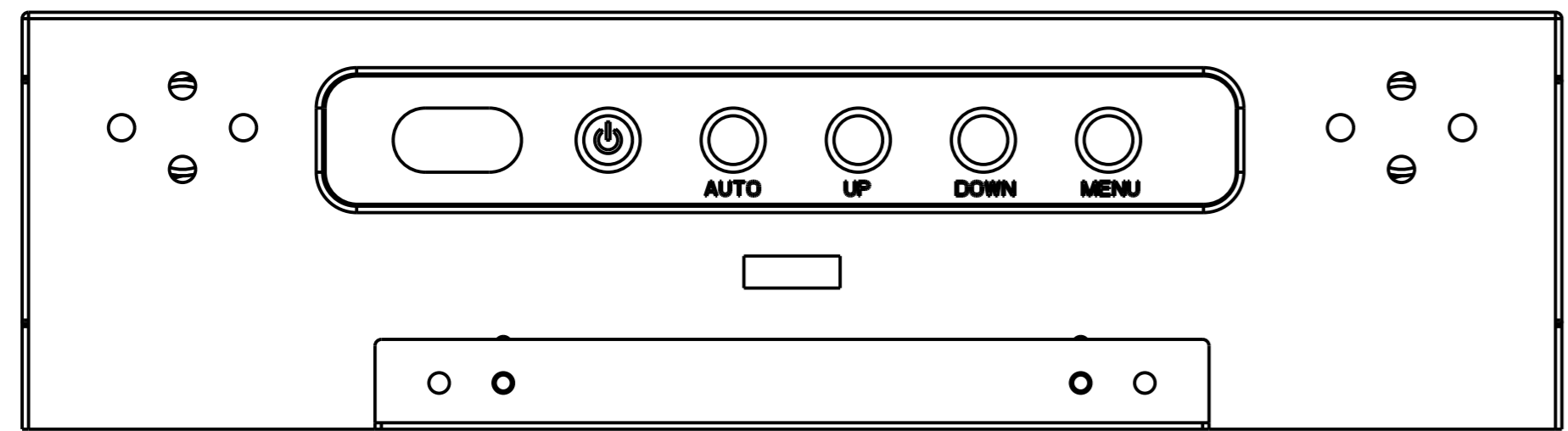

AD/BOARD		MODEL			OF0975			Winsonic Electronics. Co., Ltd.				
INVERTER												
KEY PAD												
PANEL:		VERSION	MATERIAL	DATE	ASSEMBLY		PART NAME	DRAWN		Jack	SCALE	UNIT
		V2	METAL	2013-Feb-07			APPROVED				1.000	MM

A

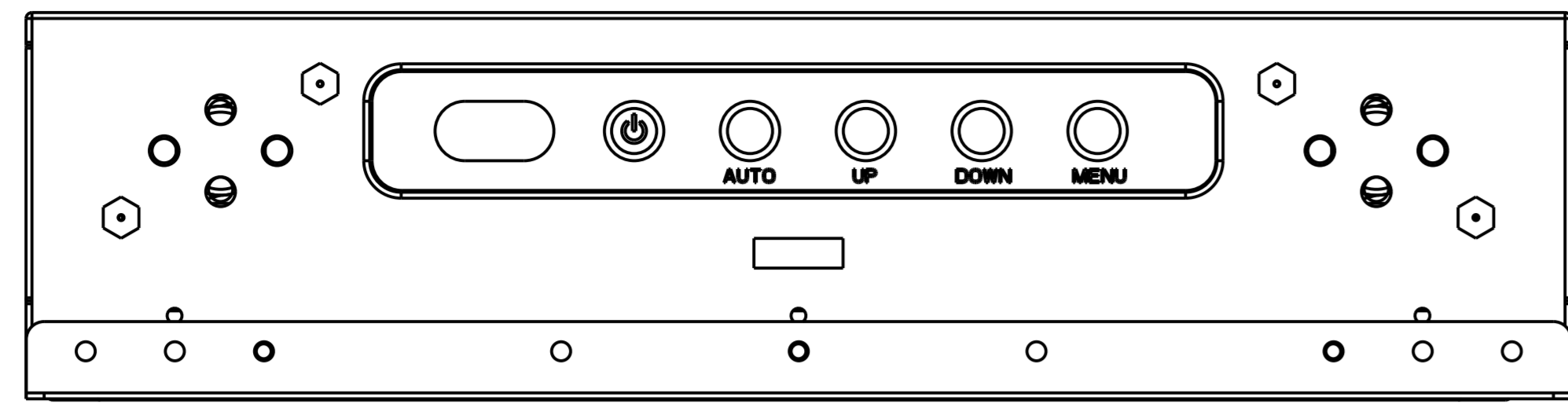

A

B

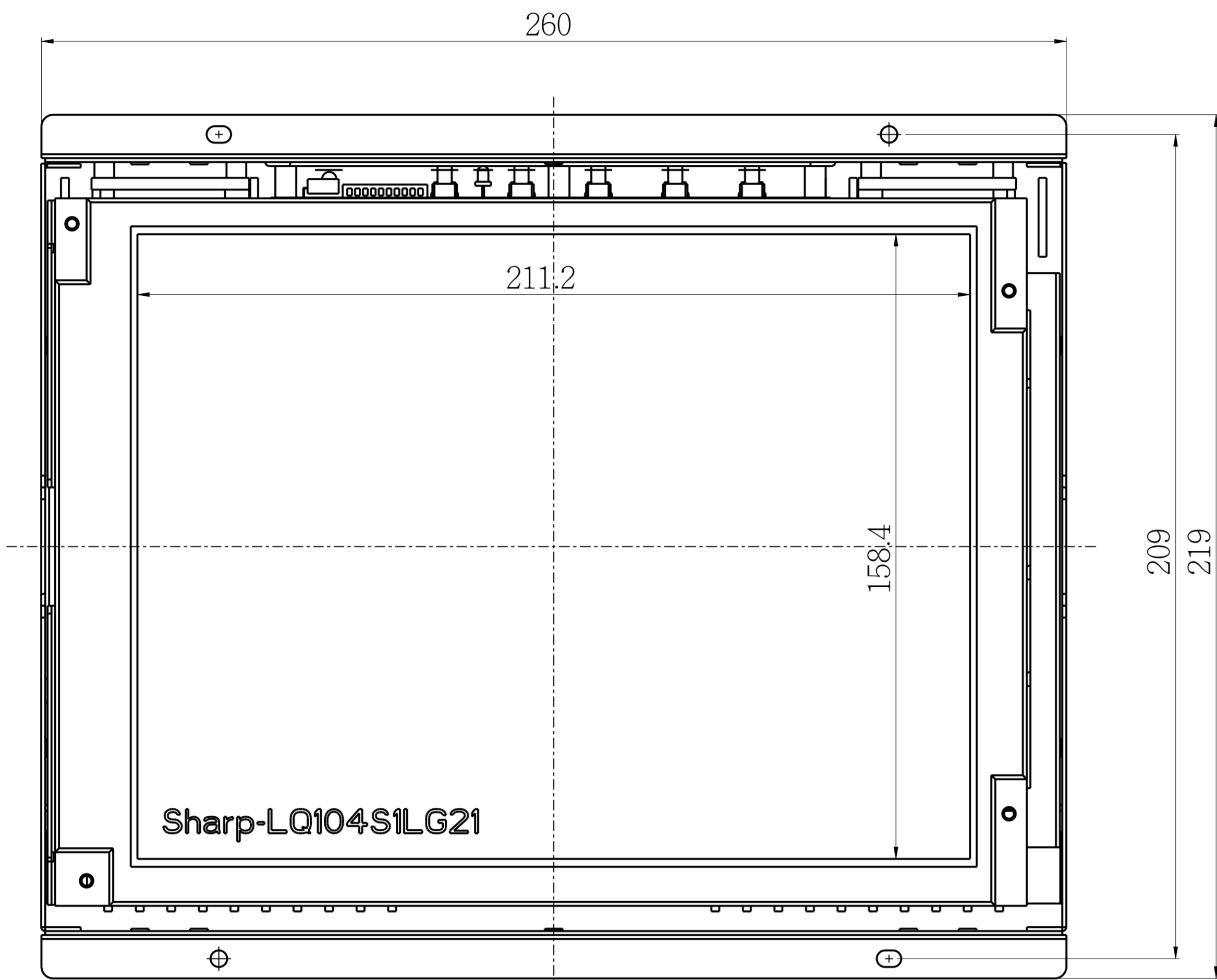

B

C

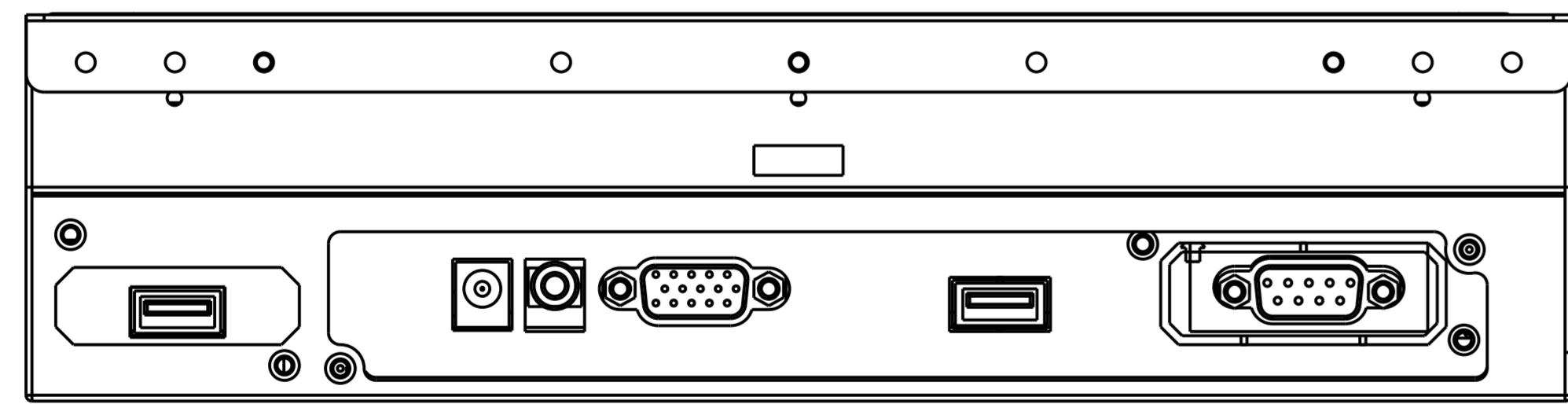

C

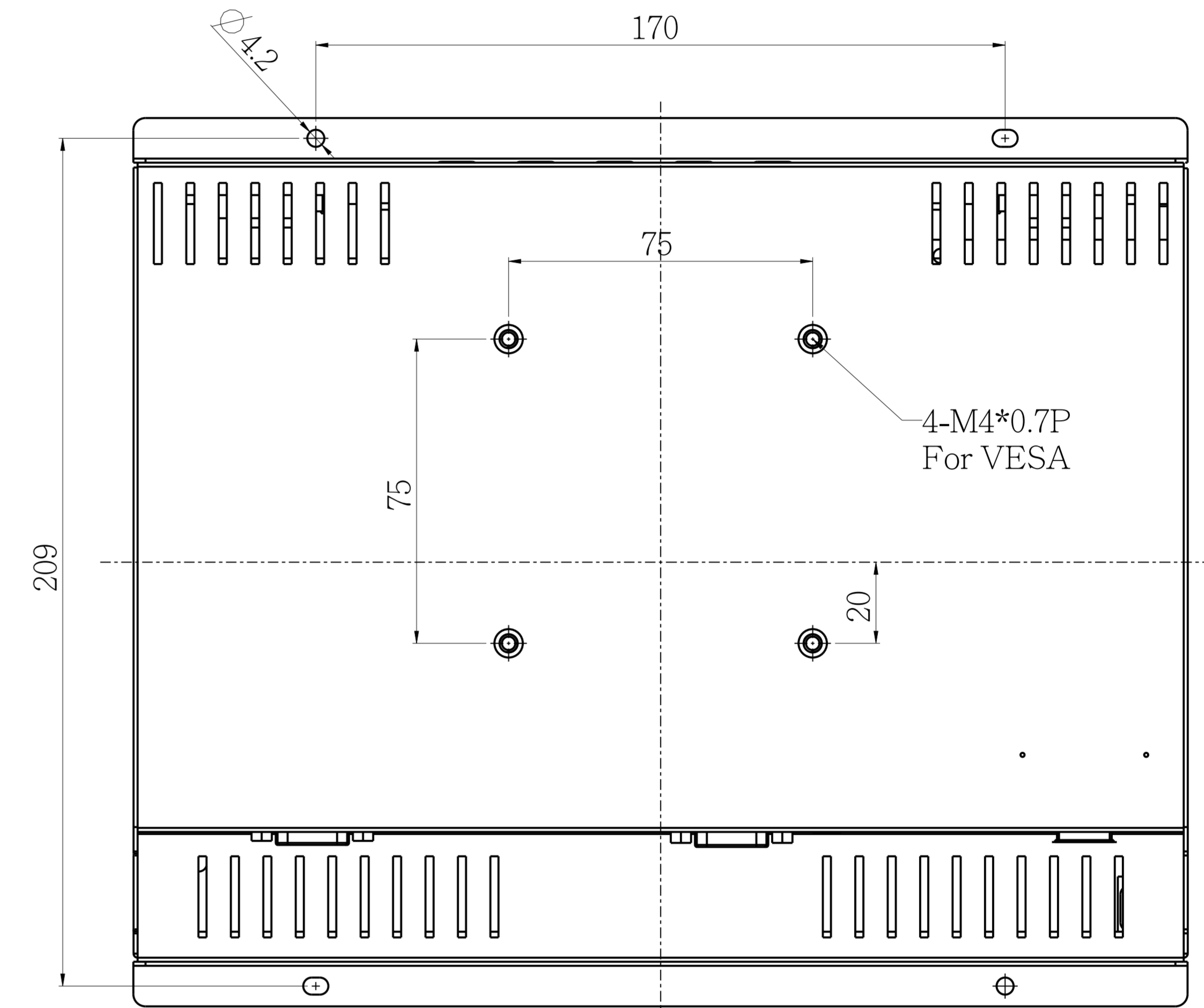
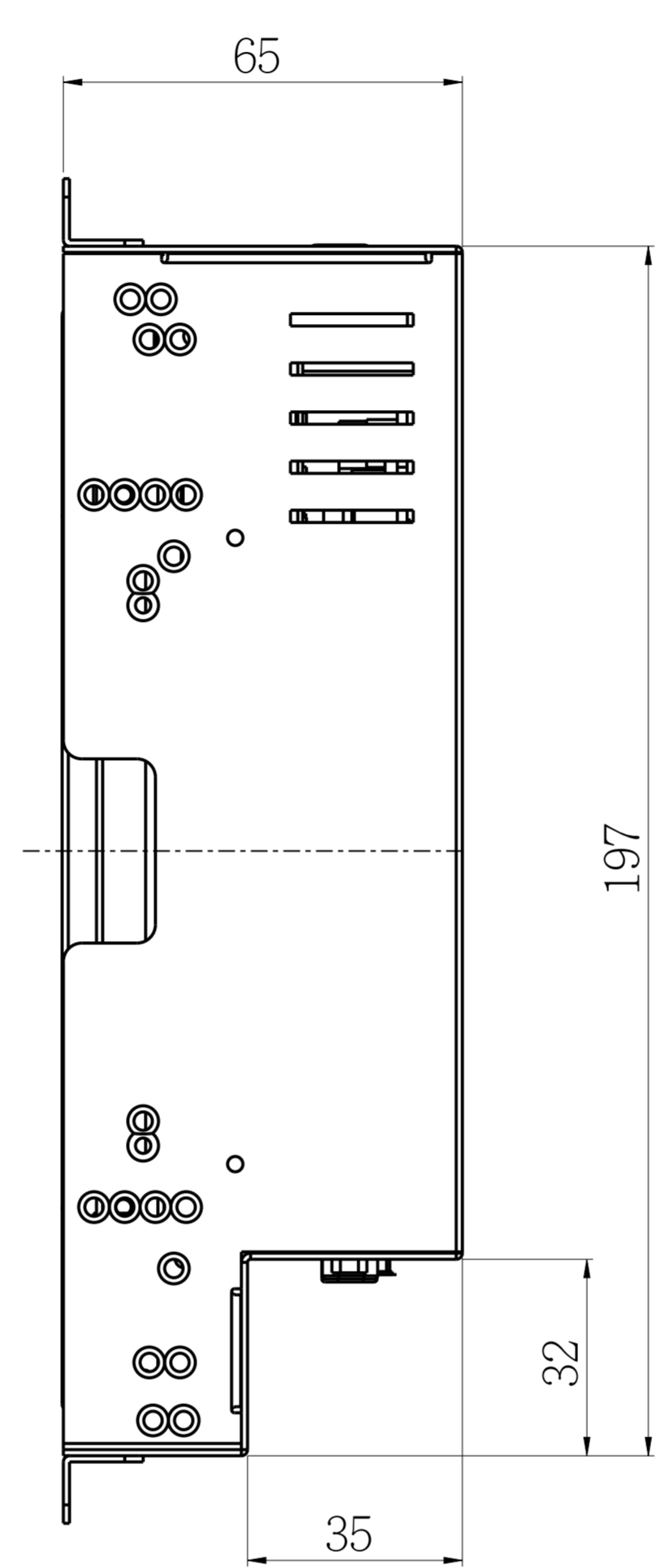

D

AD/BOARD		MODEL	OF1045	泓瑜科技有限公司 WINSONIC TECH. CO., LTD.							
INVERTER		PART NO.						PART NAME	ASSEMBLY		
KEY PAD		MATERIAL	METAL	DATE	2012-Feb-06	APPROVED		DRAWN	Jack	SCALE	1.000
PANEL:										UNIT	MM

D

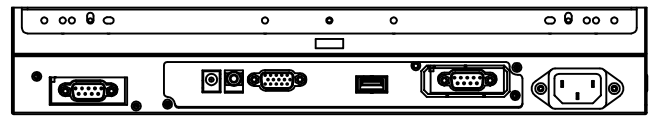
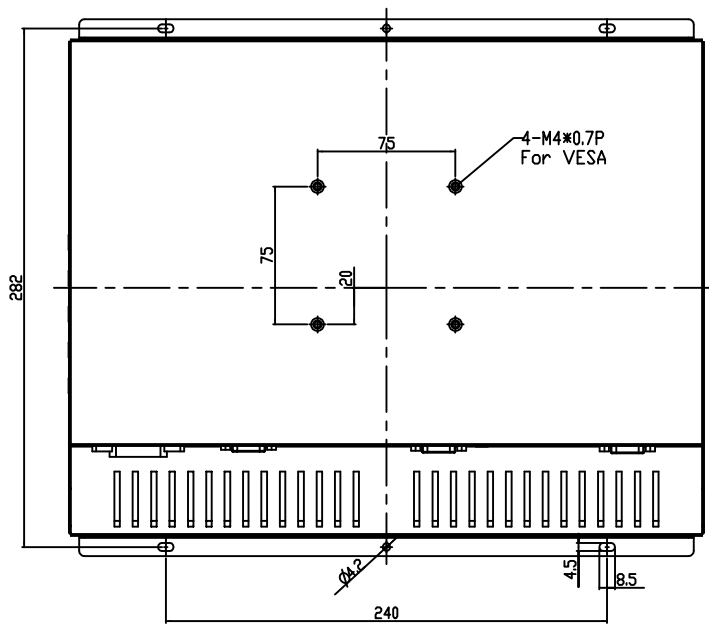
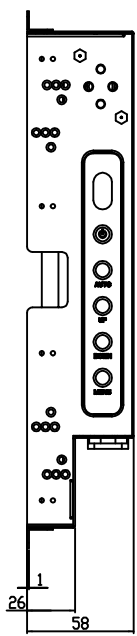
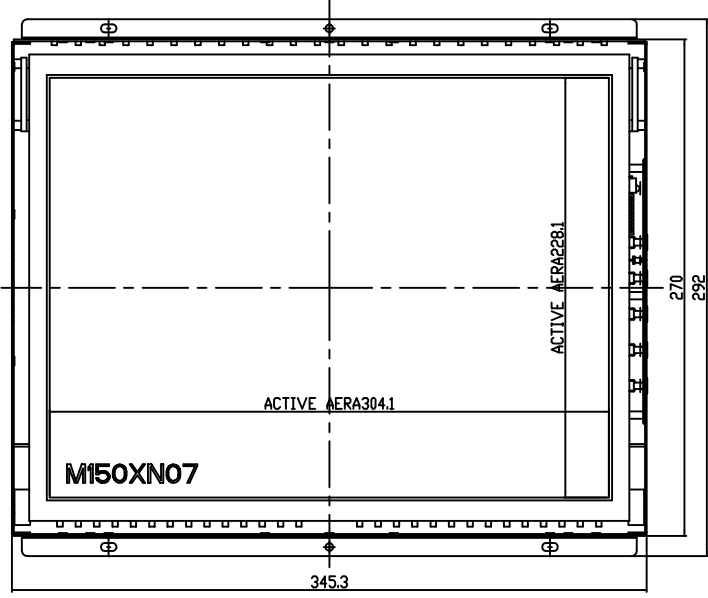

AD/BOARD		MODEL		DF1505		泓瑜科技有限公司 WINSONIC TECH. CO., LTD.						
INVERTER		PART NO.								PART NAME		ASSEMBLY
KEY PAD		MATERIAL		METAL		DATE		2010-Nov-12			1000	
PANEL:		DATE		2010-Nov-12		APPROVED		DRAWN		Jack	UNIT	MM

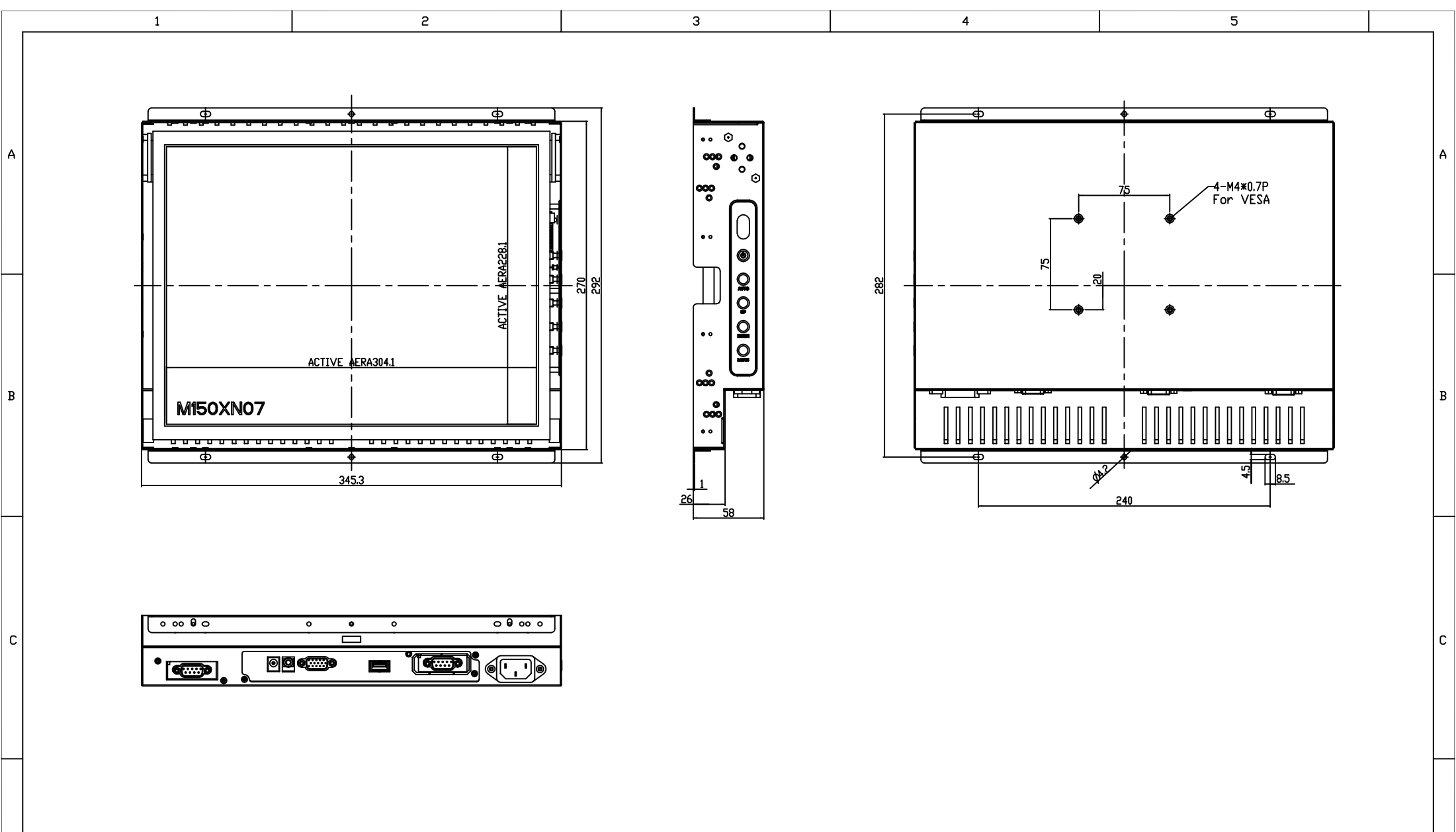

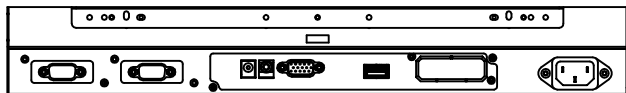
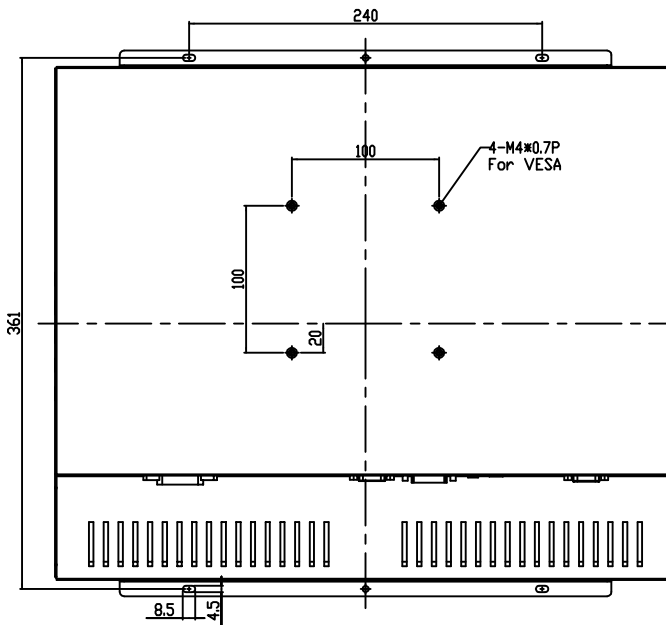
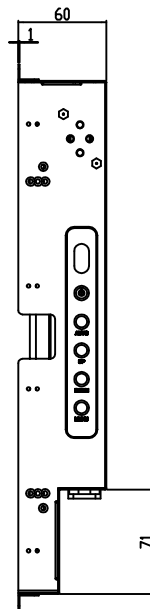
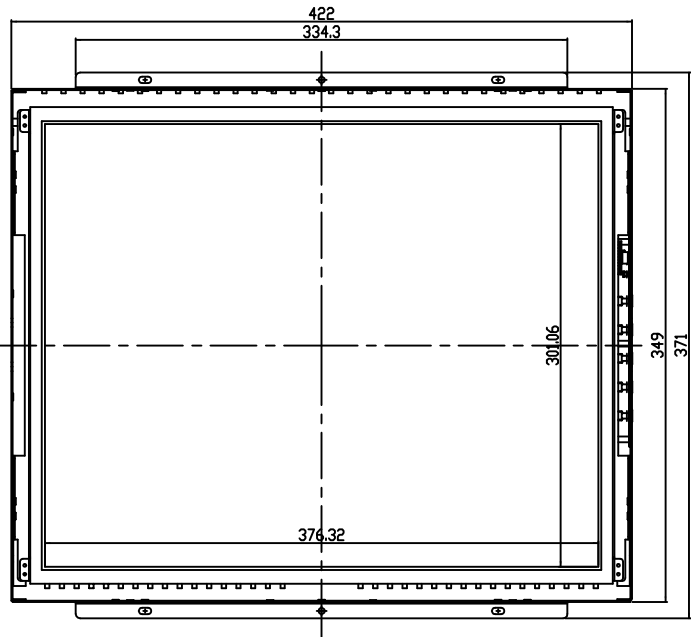

AD/BOARD		MODEL	DF1905		泓瑜科技有限公司 WINSONIC TECH. CO., LTD.						
INVERTER		PART NO.							PART NAME	ASSEMBLY	
KEY PAD		MATERIAL	METAL	DATE	2012-Aug-07	APPROVED		DRAWN	Jack	SCALE	0.800
PANEL:										UNIT	MM

1

2

3

4

5

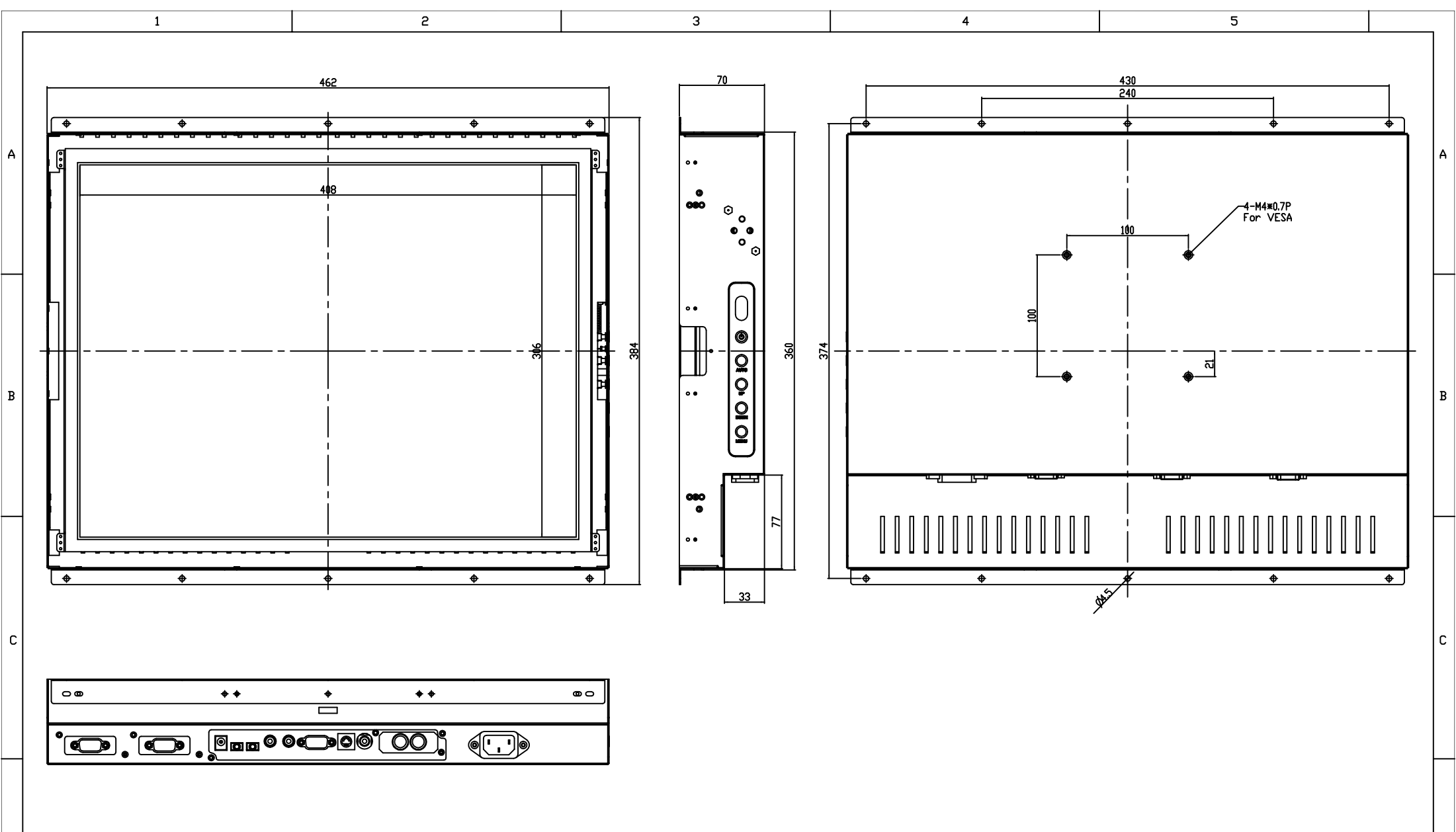

AD/BOARD		MODEL	DF2005			泓瑜科技有限公司 WINSONIC TECH. CO., LTD.				
INVERTER										
KEY PAD										
PANEL:	VERSION	MATERIAL	METAL	DATE	2012-Aug-07	PART NAME	ASSEMBLY		⊕	⚡
	V1					APPROVED	DRAWN	Jack	SCALE	UNIT
1	2	3	4	5						

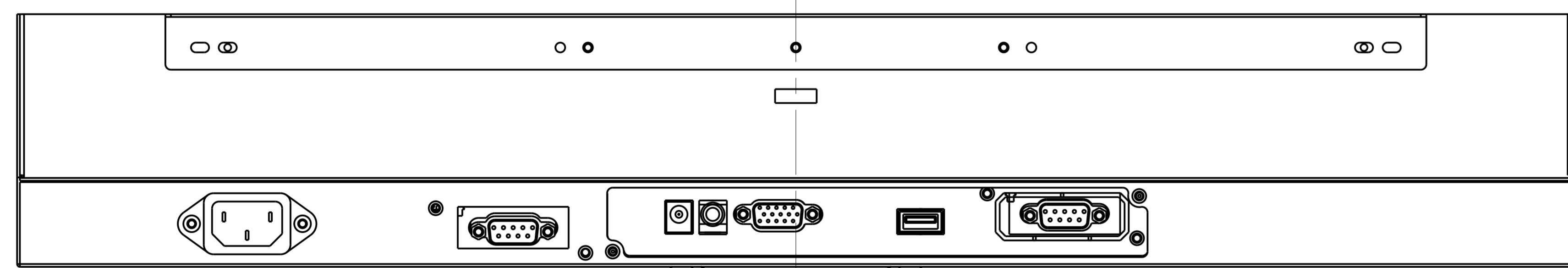
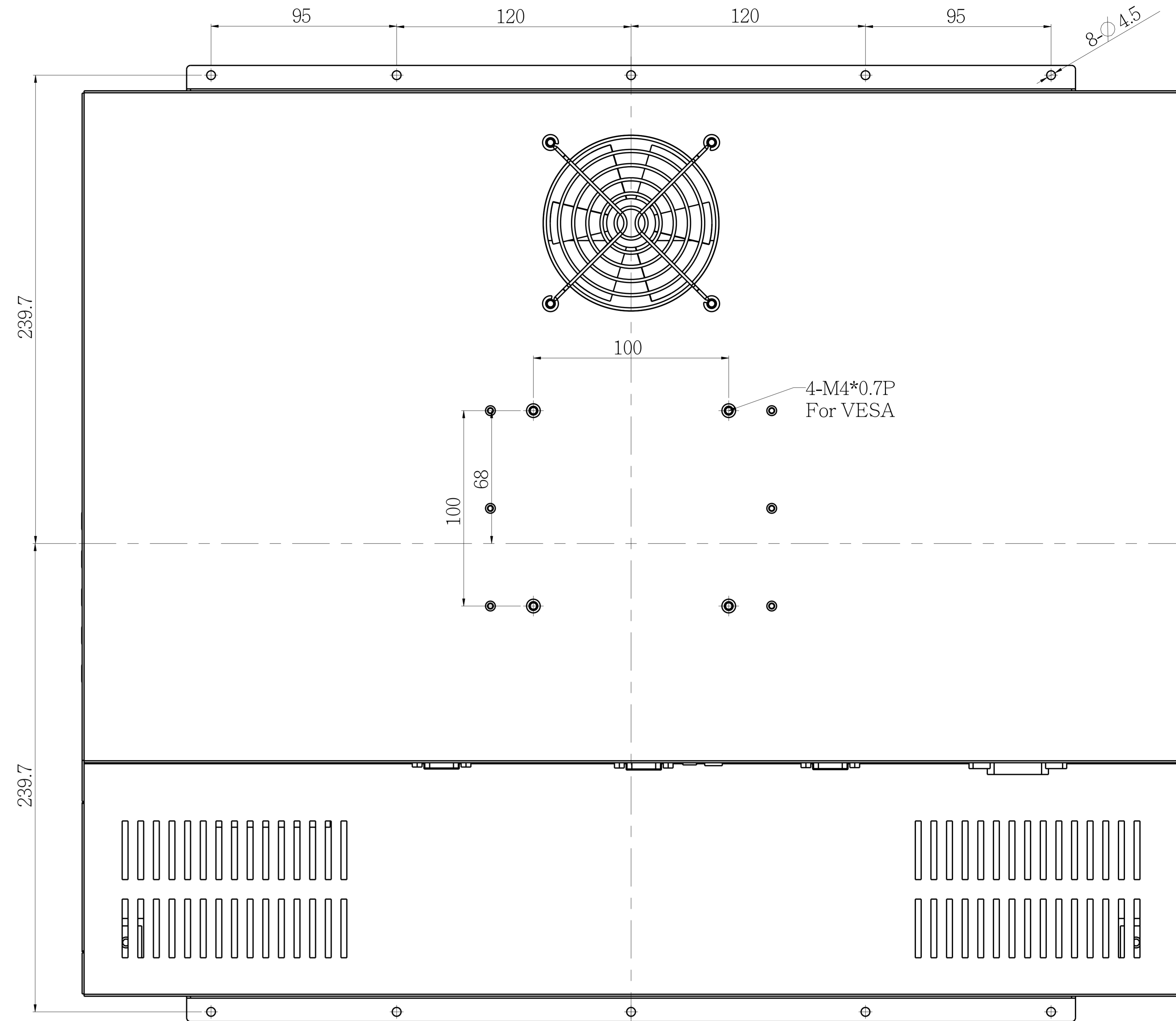
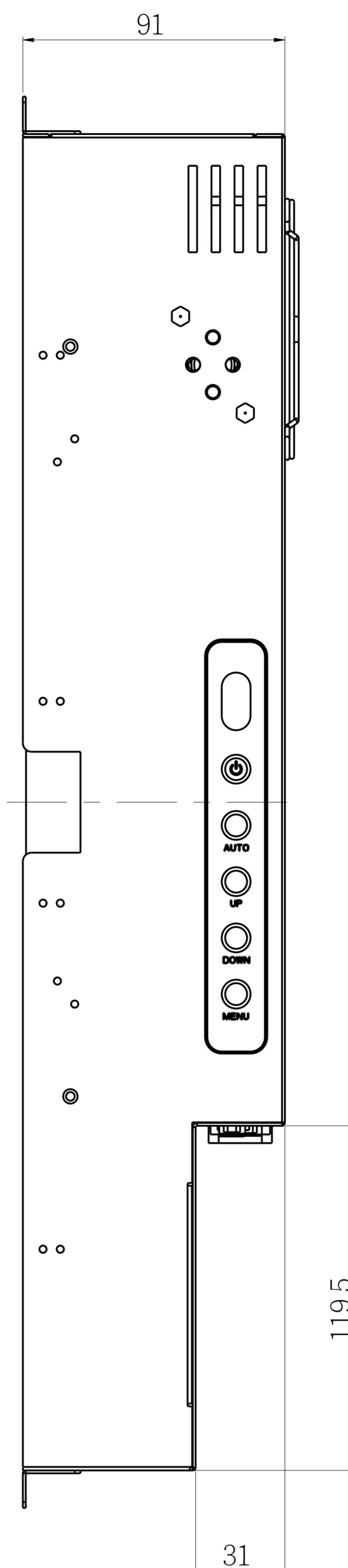
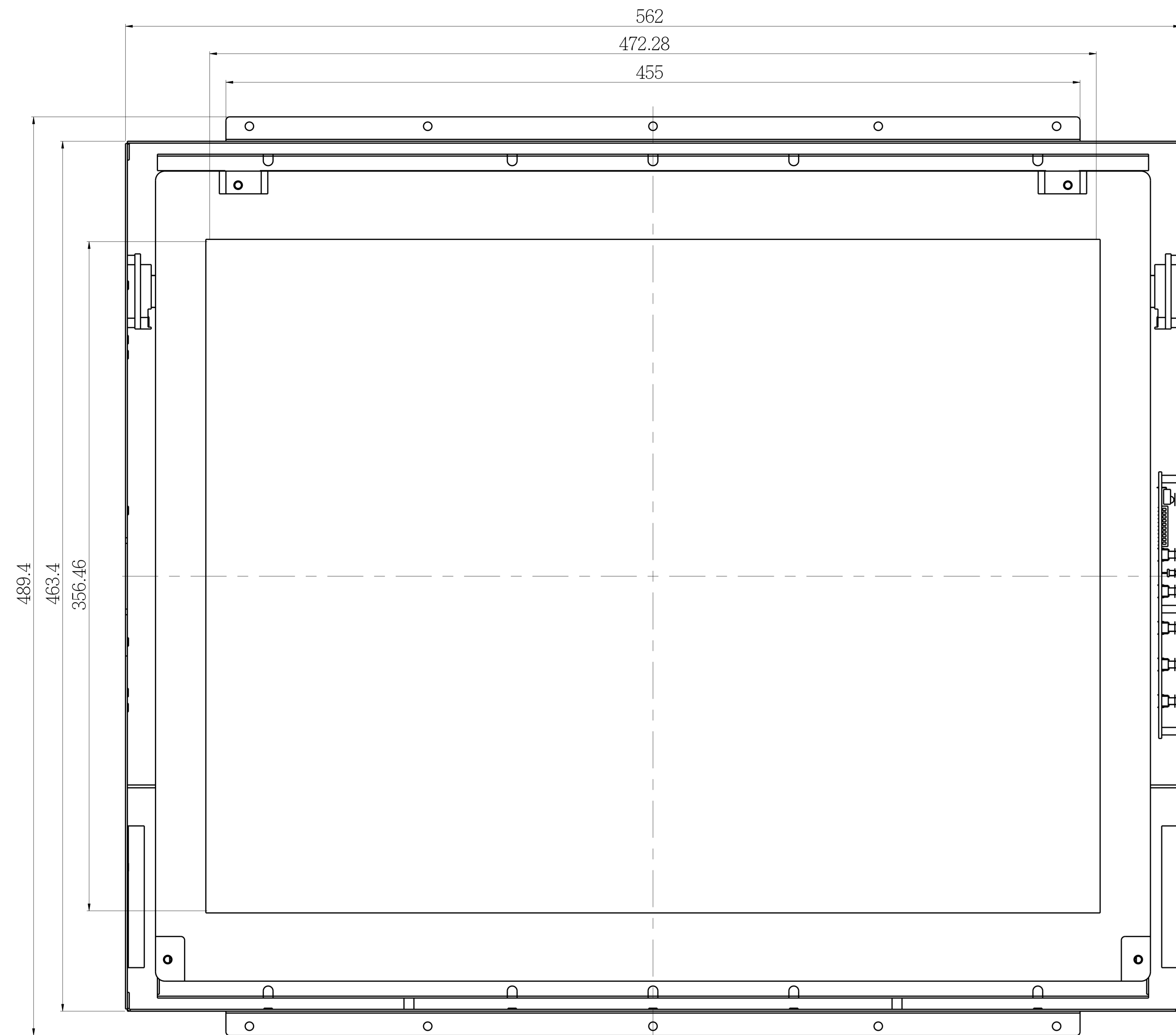

AD/BOARD		MODEL	OF2316			泓瑜科技有限公司 WINSONIC TECH. CO., LTD.					
INVERTER											
KEY PAD											
PANEL:	VERSION	MATERIAL	METAL	DATE	2012-Apr-20	PART NAME	ASSEMBLY				
	V1					APPROVED	DRAWN	Chris	SCALE	0.800	
									UNIT	MM	

1

2

3

4

5